



Product Name: MODLED

General information

- This luminaire must be installed in accordance with the latest edition of the IET Wiring Regulations and local Building Regulation by a qualified competent person.
- The mains power supply must be turned off before inspection, installation or removal of the luminaire, ensuring that the supply is locked off to prevent inadvertently switching the supply on.
- It is the installer's responsibility to ensure that the installation is suitable for the total load of the luminaire(s). The supply cable fuses/circuit breakers must be correctly rated for the electrical load and taking into account for any transient inrush currents that may occur.
- It is the installer's responsibility to ensure that the environmental operating and storage conditions are complied with and that any fire risks are considered.
- Do not perform insulation strength or insulation resistance tests on the installation with the luminaire(s) connected, this can damage the luminaires and give erroneous readings.
- Do not loop-in supply cables at the luminaire supply terminals unless there is provision for 2-way connection at the terminals.
- The light source contained in this luminaire must only be replaced by Tamlite Lighting or an appointed service agent.
- Emergency lighting luminaires must be installed and maintained in accordance with the emergency lighting standard BS 5266-1.
- To ensure that the product warranty remains valid, the luminaire must be installed and maintained in accordance with these installation instructions and the product must not be modified in any way.

-  Luminaires marked with this symbol must not be covered with thermally insulating material.
-  This symbol on covers over light sources indicates dangerous live parts do not operate the luminaire with this cover removed.

Dimensions

	A (mm)	B (mm)	C (mm)
MBL66 / PBL66	595	595	35
MBL123 / PBL123	1195	295	35
MBL126 / PBL126	1195	595	35

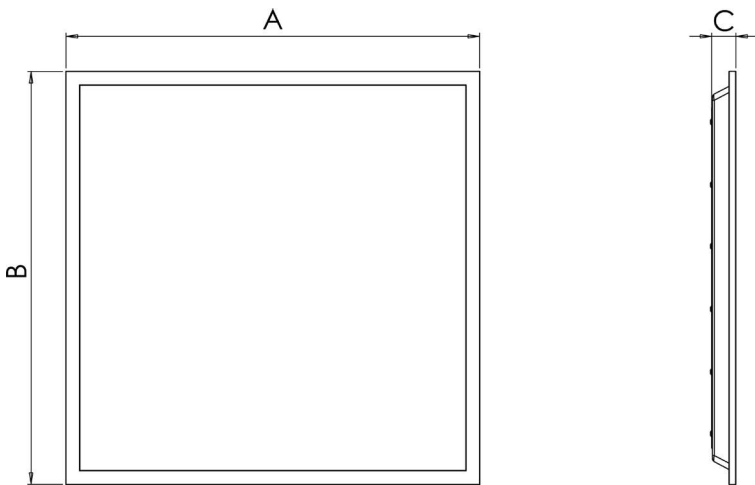

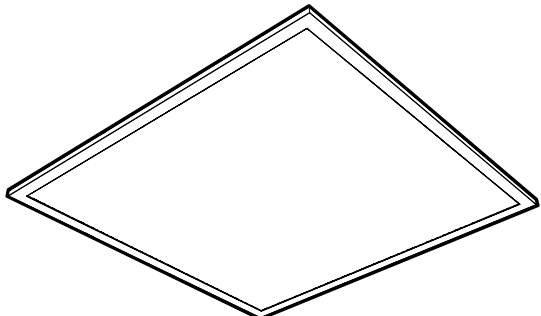
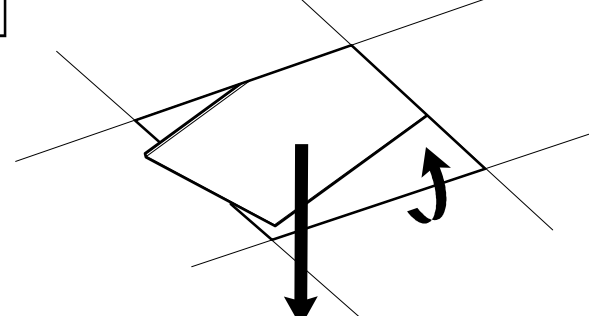
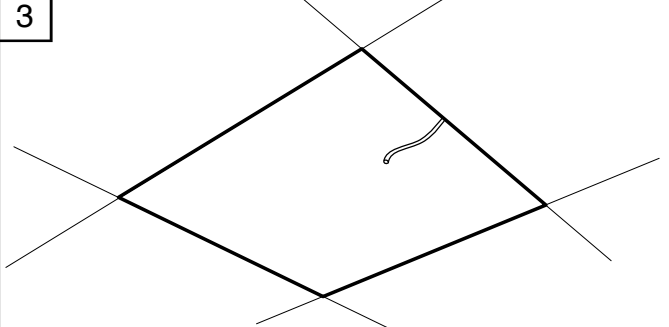
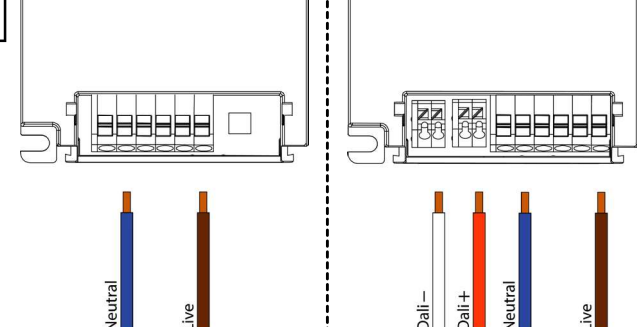
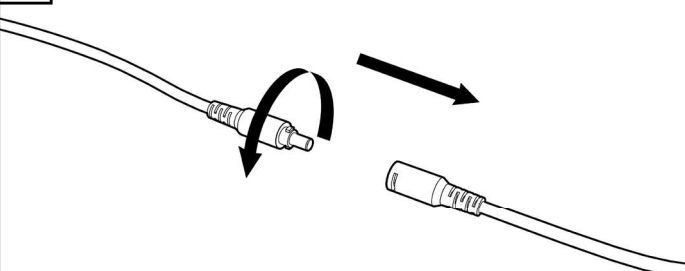
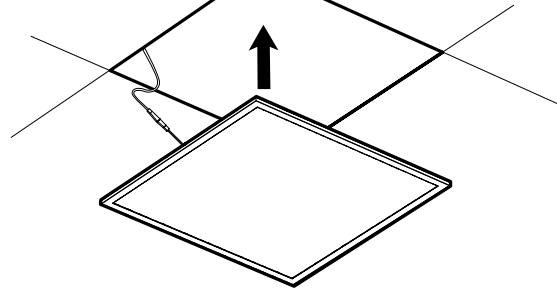
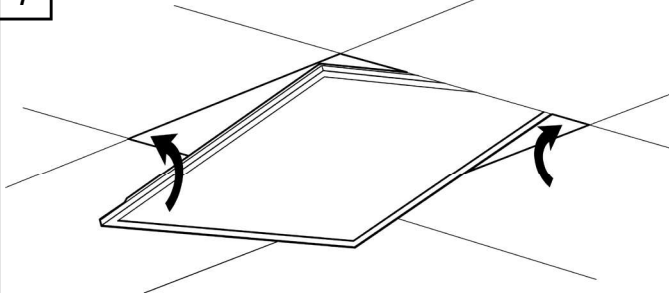
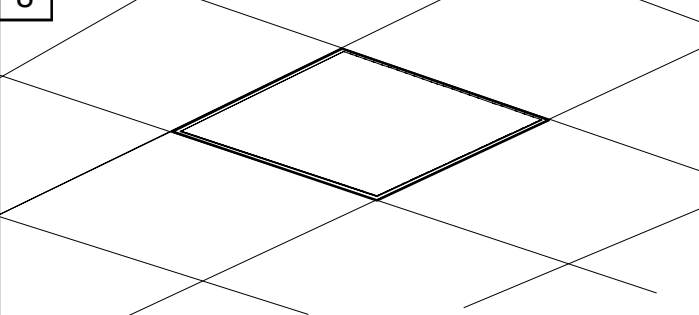

Product Name: MODLED

<p>1</p>  <p>Remove the product from its packaging.</p>	<p>2</p>  <p>Remove ceiling tile from intended position.</p>
<p>3</p>  <p>Bring incoming supply cable to the intended luminaire position.</p>	<p>4</p>  <p>Terminate supply cable according to the markings on the LED driver.</p>
<p>5</p>  <p>Connect the barrel plug between the driver and LED panel.</p>	<p>6</p>  <p>Position luminaire below intended installation position.</p>
<p>7</p>  <p>Rotate luminaire in to place.</p>	<p>8</p> 

Page 2 of 2

Tamlite Technical
Stafford Park 12,
Telford, Shropshire,
TF3 3BJ

+44(0)1952 292441
technical@tamllite.co.uk
Document No: V2

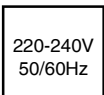
			220-240V 50/60Hz		IP44	IK04	ta 0°C to 25°C +5°C to 25°C for M3 variants
---	---	---	---------------------	--	------	------	--